

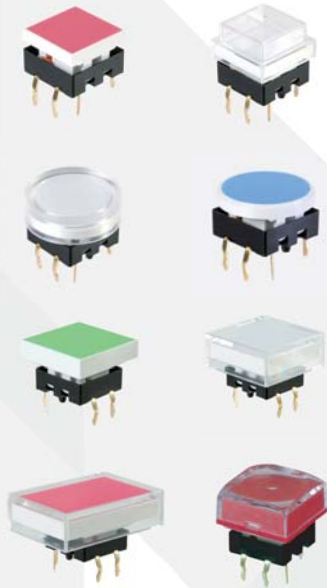

## Illuminated Tactile Switches Series SPL



**General Specifications**  
 Circuit :SPST  
 Current Rating :50mA @ 12VDC  
 Contact Resistance :100mOhm Max.(initial)  
 Insulation Resistance :100MOhm Min.  
 Operating Force :300gf ± 100gf  
 Total Travel :0.3mm±0.1mm  
 Mechanical Life :5,000,000 cycles Min.  
 Operating Temperature :-25 °C ~ +60 °C

**Materials**  
 Cover :Polycarbonate (PC)  
 Cap :Polycarbonate (PC)  
 Housing :Polyamide (PA)  
 Base :Polyamide (PA)  
 Lamp Term. :Phosphor bronze (PBS) with gold plating  
 Act. Dome :SUS with silver plating  
 End Term. :Brass with gold plating  
 LED :Surface Mount Chip LED

PAT. M 332927  
 PAT. ZL 2007 2 0311508.9

### Contact configuration

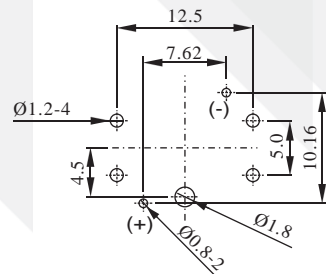

PCB Layout

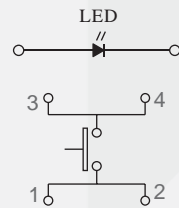

(SPST)  
 Contact Configuration

### Dimension (SPLG)

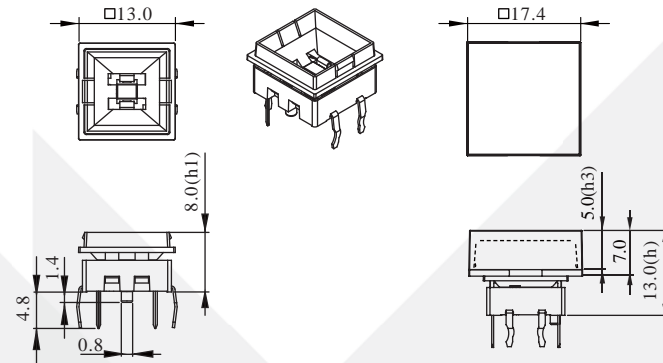

EXAMPLE:  
 SPLG1YCS0024  
 (h1) 8.0mm + (h3) 5.0mm  
 = (h)13.0mm

### How to order (SPLG)

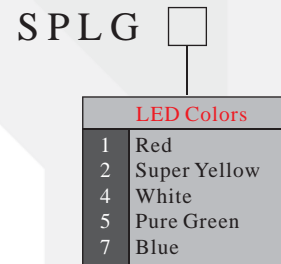

EXAMPLE:  
 SPLG1YCS0024  
 From Page 36



Page 23

**11.5**  
 Page 36



## Illuminated Tactile Switches Series SPL

### Dimension (SPL12)

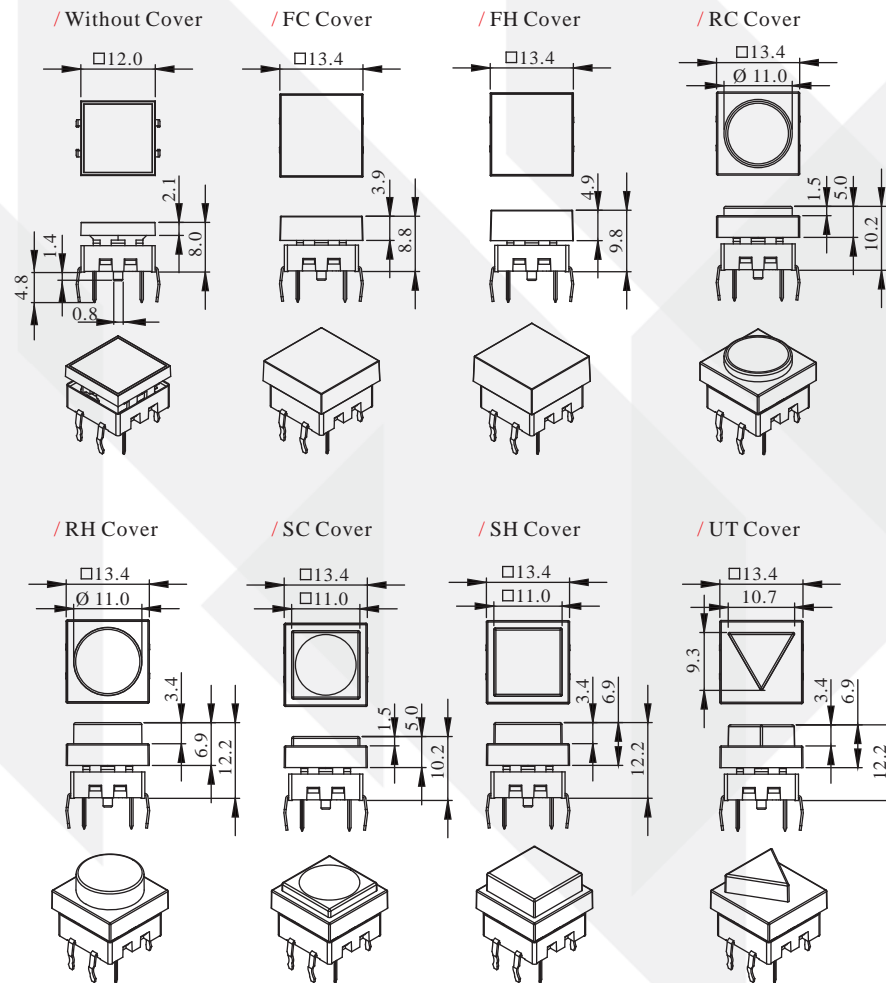

### Dimension (SPL12)

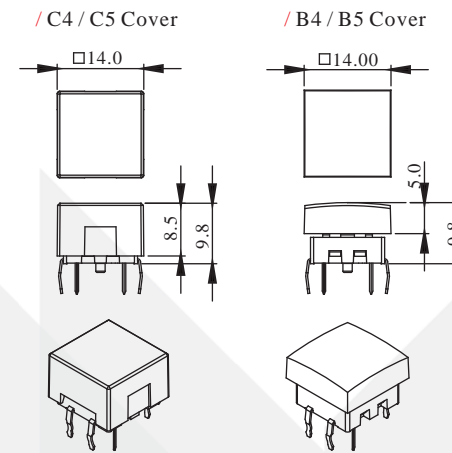

### How to order (SPL12)

S P L 1 2  -  -   -

Function Code	Diffuser Colors	LED Colors	Cover style / Color
P	1 Red 2 Yellow 3 Green 4 White	01 Red S2S Super Yellow 03 Green P3S Pure Green 4S White 7S Blue	00 Without Cover FC Flat/Clear FH Flat/Clear RC Round/Clear RH Round(High)/Clear SC Square/Clear SH Square (High)/Clear UT UP Triangle/Clear C4 Flat cover/White C5 Flat cover/Foggy B4 Raised cover/White B5 Raised cover/Clear

EXAMPLE :  
SPL12P-2-S2S-FC



## Illuminated Tactile Switches Series SPL

### Dimension (SPL15)

/ Without Cover

/ VAT Cover

/ CVT Cover

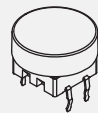
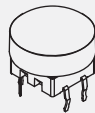
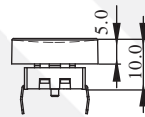
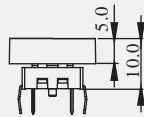
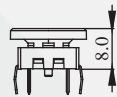

### Dimension (SPL16)

/ SPL16S Without Cover

/ SPL16S YCV001

/ SPL16R Without Cover

/ SPL16R YCV005

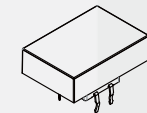
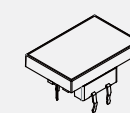
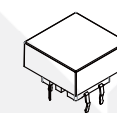
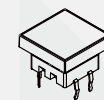
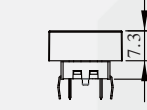
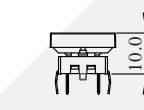
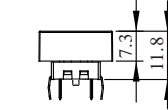
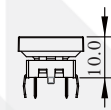
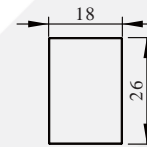
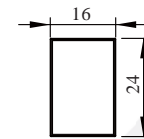
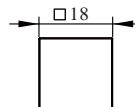
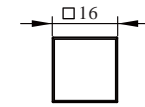

### How to order (SPL15)

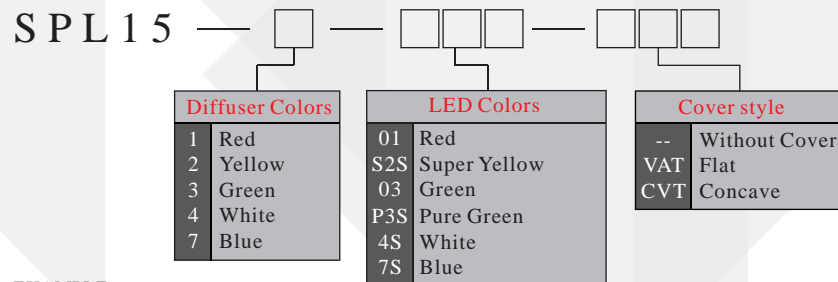

EXAMPLE :  
SPL15-1-01-VAT

### How to order (SPL16)

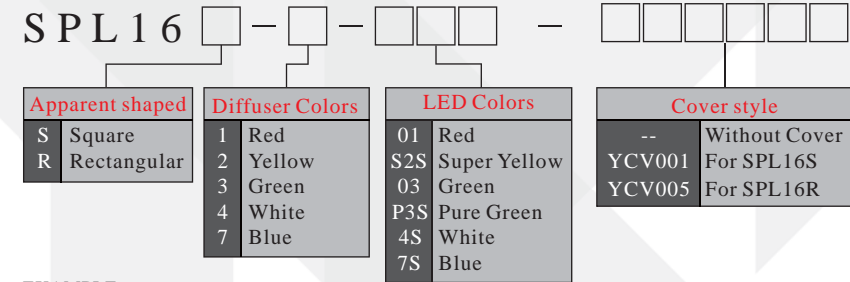

EXAMPLE :  
SPL16S-1-01-YCV001